

ICOM<sup>®</sup>

INSTRUCTION MANUAL

UHF TRANSCEIVER

**IC-F44GT/GS**

Icom Inc.

**BIIS 1200  
Compatible**



---

## IMPORTANT

---

**READ ALL INSTRUCTIONS** carefully and completely before using the transceiver.

**SAVE THIS INSTRUCTION MANUAL** — This instruction manual contains important operating instructions for the **IC-F44GT/GS UHF TRANSCEIVER**.

---

## EXPLICIT DEFINITIONS

---

WORD	DEFINITION
<b>⚠ WARNING</b>	Personal injury, fire hazard or electric shock may occur.
<b>CAUTION</b>	Equipment damage may occur.
<b>NOTE</b>	If disregarded, inconvenience only. No risk of personal injury, fire or electric shock.

Icom, Icom Inc. and the  ICOM logo are registered trademarks of Icom Incorporated (Japan) in the United States, the United Kingdom, Germany, France, Spain, Russia and/or other countries.

SmarTrunk II™ and SmarTrunk 3G™ are Trademark of SmarTrunk Systems, Inc.

---

## PRECAUTION

---

**⚠ CAUTION! NEVER** hold the transceiver so that the antenna is very close to, or touching exposed parts of the body, especially the face or eyes, while transmitting. The transceiver will perform best if the microphone is 5 to 10 cm away from the lips and the transceiver is vertical.

**⚠ CAUTION! NEVER** operate the transceiver with a headset or other audio accessories at high volume levels.

**⚠ CAUTION! NEVER** short the terminals of the battery pack.

**DO NOT** push PTT when not actually desiring to transmit.

**AVOID** using or placing the transceiver in direct sunlight or in areas with temperatures below  $-25^{\circ}\text{C}$  or above  $+55^{\circ}\text{C}$ .

The basic operations, transmission and reception of the transceiver are guaranteed within the specified operating temperature range. However, the LCD display may not be operate correctly, or show an indication in the case of long hours of operation, or after being placed in extremely cold areas.

---

---

**DO NOT** modify the transceiver for any reason.

**KEEP** the transceiver from the heavy rain, and **NEVER** immerse it in the water. The transceiver construction is **water resistant**, not waterproof.

The use of non-Icom battery packs/chargers may impair transceiver performance and invalidate the warranty.

---

# TABLE OF CONTENTS

---

IMPORTANT .....	i	■ Printer connection .....	25
EXPLICIT DEFINITIONS .....	i	■ Digital ANI .....	25
PRECAUTION .....	i	■ Auto emergency transmission .....	26
TABLE OF CONTENTS .....	iii	■ Stun function .....	26
<b>1 ACCESSORIES .....</b>	<b>1–3</b>	■ BIIS indication .....	26
■ Supplied accessories .....	1	■ Priority A channel selection .....	26
■ Accessory attachments .....	1	■ Man Down Emergency Call .....	27
<b>2 PANEL DESCRIPTION .....</b>	<b>4–10</b>	<b>5 OPTIONAL SmarTrunk OPERATION .....</b>	<b>28–29</b>
■ Front panel .....	4	■ SmarTrunk II™, SmarTrunk 3G™	
■ Function display .....	6	and conventional modes .....	28
■ Programmable function keys .....	7	■ SmarTrunk II™ and SmarTrunk 3G™ operation.....	28
<b>3 BASIC OPERATION .....</b>	<b>11–15</b>	<b>6 OPTIONAL UNIT INSTALLATION .....</b>	<b>30–31</b>
■ Turning power ON .....	11	■ Optional unit installation .....	30
■ Channel selection .....	11	■ Scrambler unit installation .....	31
■ Call procedure.....	12	<b>7 BATTERY CHARGING .....</b>	<b>32–35</b>
■ Receiving and transmitting.....	12	■ Battery charging .....	32
■ User Set mode .....	15	■ Battery caution .....	32
■ Scrambler function .....	15	■ Optional battery chargers .....	33
<b>4 BIIS OPERATION .....</b>	<b>16–27</b>	<b>8 SWIVEL BELT CLIP .....</b>	<b>36–37</b>
■ Default setting .....	16	■ MB-93 contents .....	36
■ Receiving a call .....	16	■ To attach .....	36
■ Transmitting a call .....	18	■ To detach .....	37
■ Receiving a message .....	20	<b>9 OPTIONS .....</b>	<b>38–39</b>
■ Transmitting a status .....	22	<b>10 DOC .....</b>	<b>40</b>
■ Transmitting an SDM .....	23		
■ Position data transmission .....	25		

## ■ Supplied accessories

The following accessories are supplied:

	Qty.
① Flexible antenna .....	1
② Battery pack .....	1
③ Belt clip .....	1
④ Jack cover (with screws) .....	1 set

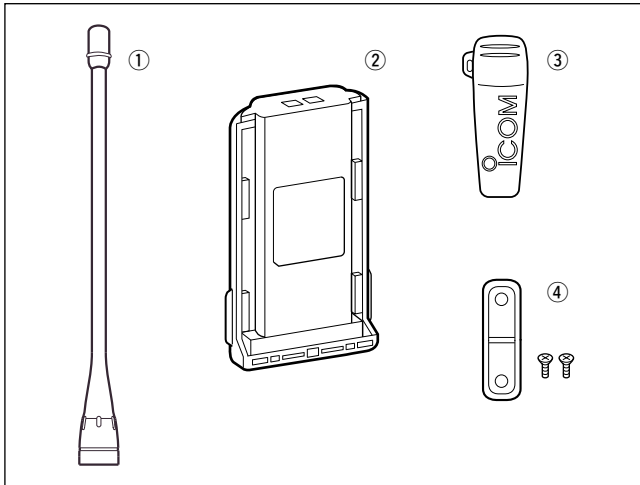

## ■ Accessory attachments

◇ **Flexible antenna**  
Connect the supplied flexible antenna to the antenna connector.

- CAUTION!**
- **NEVER HOLD** by the antenna when carrying the transceiver.
  - Transmitting without an antenna may damage the transceiver.

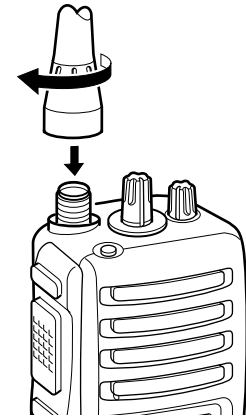

# 1 ACCESSORIES

## ◇ Battery pack

### *To attach the battery pack:*

Slide the battery pack in the direction of the arrow (❶), then lock it with the battery release button.

- Slide the battery pack until the battery release button makes a 'click' sound.

### *To release the battery pack:*

Push the battery release button in the direction of the arrow (❷) as shown below. The battery pack is then released.

/// **NEVER** release or attach the battery pack when the transceiver is wet or soiled. This may result water or dust getting into the transceiver/battery pack and may result in the transceiver being damaged.

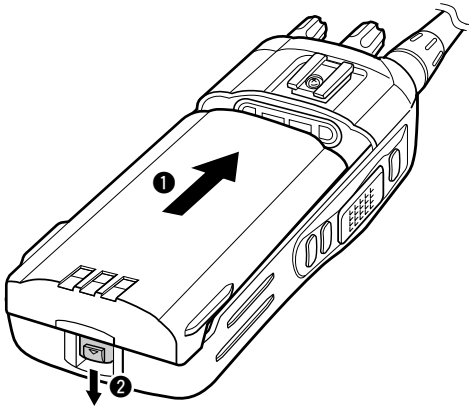

## ◇ Belt clip

### *To attach the belt clip:*

- ❶ Release the battery pack if it is attached.
- ❷ Slide the belt clip in the direction of the arrow until the belt clip is locked and makes a 'click' sound.

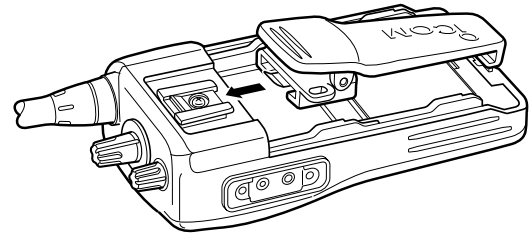

### *To detach the belt clip:*

- ❶ Release the battery pack if it is attached.
- ❷ Pinch the clip (❶), and slide the belt clip in the direction of the arrow (❷).

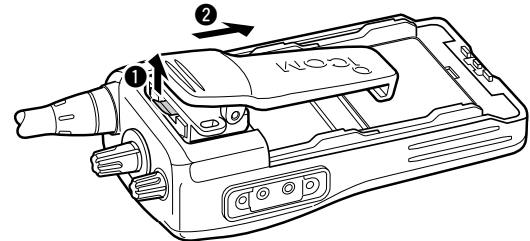

### ◇ Jack cover

Attach the jack cover when the optional speaker-microphone is not used.

#### **To attach the jack cover:**

- 1 Attach the jack cover on the [SP]/[MIC] jack.
- 2 Tighten the screws.

#### **To detach the jack cover:**

- 1 Unscrew the screws with a Phillips screwdriver.
- 2 Detach the jack cover for the speaker-microphone connection.

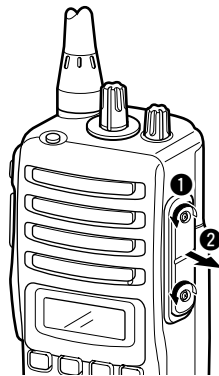
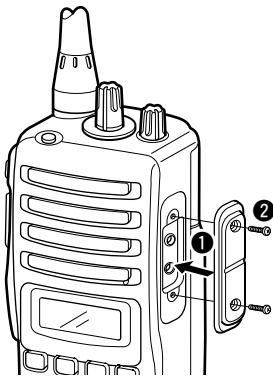

## ■ Front panel

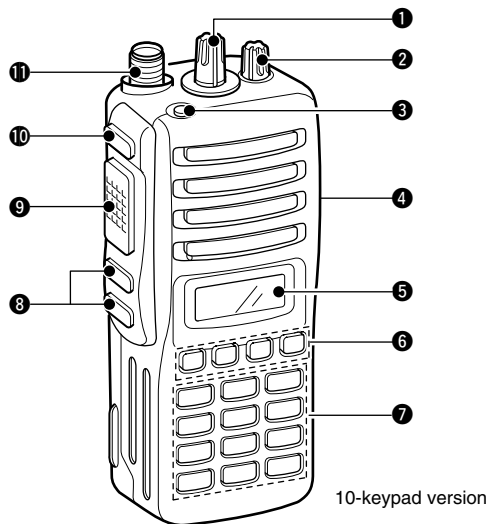

### 1 ROTARY SELECTOR

Rotate to select the pre-programmed memory channels or the operating bank.  
(Depending on the pre-setting)

### 2 VOLUME CONTROL [VOL]

Rotate to turn the power ON/OFF and adjusts the audio level.

### 3 DEALER-PROGRAMMABLE KEY [RED]

Desired function can be programmed by your dealer.  
(p. 7)

### 4 [SP]/[MIC] JACK

Connect the optional speaker-microphone.

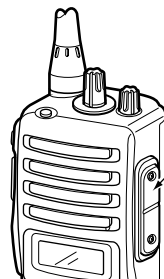

[SP]/[MIC] jack cover

**NOTE:** Attach the [SP]/[MIC] jack cover when the optional speaker-microphone is not used.  
(See p. 3 for details)

### 5 FUNCTION DISPLAY

Displays a variety of information such as an operating channel number/name, 5-tone code, DTMF numbers, selected function, etc.

### 6 DEALER-PROGRAMMABLE KEYS [P0] to [P3]

Desired functions can be programmed independently by your dealer. (p. 7)



**7 10-KEYPAD** (Depending on version)

The keypad allows you to enter digits to:

- Select memory channels
- Select tone channels
- Select DTMF codes (during transmit)
- Set TX codes
- Set SmarTrunk II™/SmarTrunk 3G™ codes
- Set BIIS status number
- Input text message for SDM operation
- Start up with the passcode

**8 UP/DOWN KEYS**

- Push to select an operating channel.
- Push to select a TX code channel after pushing [TX CODE CH SELECT].
- Push to select a DTMF channel after pushing [DTMF].
- Push to select a scan group after pushing and holding [SCAN].
- Push to select a BIIS code, status number or SDM after pushing [DIGITAL].

\*Desired functions can be programmed independently by your dealer. (p. 7)

**9 PTT SWITCH [PTT]**

- Push and hold to transmit; release to receive.
- Push to transmit the call during MSK operation, depending on the setting.

**10 MONITOR KEY**

Activates one of (or two of) the following functions on each channel independently.

- Push and hold the key to unmute the channel (audio is emitted; 'audible' condition).
- Push the key to toggle the mute and unmute conditions (toggles 'audible' and 'inaudible').
- Push the key to mute the channel (sets to 'inaudible' only).
- Push the key to unmute the channel (sets to 'audible' only).
- Push the key after communication is finished to send a 'reset code.'
- Push the key after communication is finished to send a 'clear down code' during BIIS operation on an MSK channel

**NOTE:** The unmute condition ('audible' conditions) may automatically return to the mute condition ('inaudible' condition) after a specified period.

\*Desired function can be programmed by your dealer. (p. 7)

**11 ANTENNA CONNECTOR**

Connects the supplied antenna.

## 2 PANEL DESCRIPTION

### ■ Function display

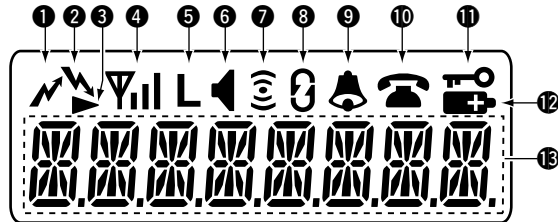

#### ❶ TRANSMIT INDICATOR

Appears while transmitting.

#### ❷ BUSY INDICATOR

Appears while the channel is busy.

#### ❸ SCROLL INDICATOR

Appears when a received SDM including more than 8 characters is displayed.

#### ❹ SIGNAL STRENGTH INDICATOR

Indicates relative signal strength level.

#### ❺ LOW POWER INDICATOR

Appears when low output power is selected.

- When the battery power decreases to a specified level, low power is selected automatically.

#### ❻ AUDIBLE INDICATOR

- Appears when the channel is in the 'audible' (unmute) condition.
- Appears when the specified 5-tone/BIIS code is received.

#### ❼ COMPANDER INDICATOR

Appears when the compander function is activated.

#### ❽ SCRAMBLER INDICATOR

Appears when the voice scrambler function is activated.

#### ❾ BELL INDICATOR

Appears/blinks when the specific 5-tone/BIIS code is received, according to the pre-programming.

#### ❿ CALL CODE MEMORY INDICATOR

Appears when the call code memory is selected.

#### ⓫ KEY LOCK INDICATOR

Appears during the key lock function is ON.

#### ⓬ BATTERY INDICATOR

Appears or blinks when the battery power decreases to a specified level.

#### ⓭ ALPHANUMERIC DISPLAY

Displays an operating channel number, channel name, Set mode contents, DTMF code, etc.

## ■ Programmable function keys

The following functions can be assigned to [UP], [DOWN], [P0], [P1], [P2], [P3], [RED] and [MONITOR] programmable function keys.

Consult your Icom dealer or system operator for details concerning your transceivers programming.

If the programmable function names are bracketed in the following explanations, the specific key is used to activate the function depends on the programming.

### **CH UP AND DOWN KEYS**

- Push to select an operating channel.
- Push to select a transmit code channel after pushing [TX Code CH Select].
- Push to select a DTMF channel after pushing [DTMF Autodial].
- Push to select a scan group after pushing and holding [Scan A Start/Stop]/[Scan B Start/Stop].
- Push to select a BIIS code, status number or SDM after pushing [Digital].

### **BANK SELECT KEY**

Push this key, then push [CH Up] or [CH Down] to select the desired bank.

### **SCAN A KEY**

- This key's operation depends on the Power ON Scan setting.

#### **When the power ON scan function is turned OFF;**

Push to start and cancel scanning operation. In case of transmission during scan, cancels scanning.

#### **When the power ON scan function is turned ON;**

Push to pause scanning. Scanning resumes after passing a specified time period. In case of transmission during scan, pauses scanning. Scanning resumes after passing a specified time period.

- Push and hold this key for 1 sec. to indicate the scan group, then push [CH Up] or [CH Down] to select the desired group.

### **SCAN B KEY**

- Push to start and cancel scanning operation. In case of transmission during scan, pauses scanning. Scanning resumes after passing a specified time period.
- Push and hold this key for 1 sec. to indicate the scan group, then push [CH Up] or [CH Down] to select the desired group.

---

## 2 PANEL DESCRIPTION

### **SCAN TAG KEY**

Push to add or cancel the selected channel to the scan group.

### **PRIORITY CHANNEL KEYS**

- Push to select Priority A or Priority B channel.
- Push and hold [Prio A (Rewrite)] to rewrite the Prio A channel.

### **MR-CH 1/2/3/4 KEYS**

Push to select an operating channel directly.

### **MONITOR KEY**

Activates one of (or two of) the following functions on each channel independently:

- Push and hold to un-mute the channel (audio is emitted; 'Audible' condition).
- Push to mute the channel (sets to 'Inaudible' only).
- Push to un-mute the channel (sets to 'Audible' only).
- Push after the communication is finished to send a 'reset code'.

 **NOTE:** The un-mute condition ('Audible' condition) may automatically return to the mute condition ('Inaudible' condition) after a specified period.

### **LOCK KEY**

Push and hold to electronically lock all programmable keys except the following:  
[Call] (incl. Call A and Call B), [Moni(Audi)] and [Emergency].

### **OUTPUT POWER SELECTION KEY**

Push to select the transmit output power temporarily or permanently, depending on the pre-setting.

- Ask your dealer for the output power level for each selection.

### **C.TONE CHANNEL ENTER KEY**

Push to select the continuous tone channel using [CH Up]/[CH Down] to change the tone frequency/code setting after pushing this key for permanent operation.

### **TALK AROUND KEY**

Turn the talk around function ON and OFF.

- The talk around function equalizes the transmit frequency to the receive frequency for transceiver-to-transceiver communication.

### **WIDE/NARROW KEY**

Push to toggle the IF bandwidth between wide and narrow.

- The wide passband width can be selected from 25.0 or 20.0 kHz using the CS-F33G CLONING SOFTWARE. Ask your Dealer for details.

**DTMF AUTODIAL KEY**

- Push to enter the DTMF channel selection mode. Then select the desired DTMF channel using [CH Up]/[CH Down] keys.
- After selecting the desired DTMF channel, push this key to transmit the DTMF code.

**DTMF RE-DIAL KEY**

Push to transmit the last-transmitted DTMF code.

**CALL KEYS**

Push to transmit a 5-tone/BIIS ID code.

- Call transmission is necessary before you call another station depending on your signalling system.
- [Call A] and/or [Call B] may be available when your system employs selective 'Individual/Group' calls. Ask your dealer which call is assigned to each key.

**EMERGENCY KEYS**

- Push and hold to transmit an emergency call.
- When [Emergency Single (Silent)] or [Emergency Repeat (Silent)] is pushed, an emergency call is transmitted without a beep emission and LCD indication change.
  - If you want to cancel the emergency call, push (or push and hold) the key again before transmitting the call.
  - The emergency call is transmitted one time only or repeatedly until receiving a control code depending on the pre-setting.

**TX CODE ENTER KEY**

Push to enter the direct ID code edit mode, for both 5-tone and MSK. Then set the desired digit using [CH Up]/[CH Down]/[TX Code CH Up]/[TX Code CH Down] or 10-keypad.\* (p. 14)

\*Depending on version

**TX CODE CHANNEL SELECT KEY**

- Push to enter the direct ID code channel selection mode. Then set the desired channel using [CH Up]/[CH Down]/[TX Code CH Up] or [TX Code CH Down]. (p. 13)
- While in ID code channel selection mode, push for 1 sec. to enter the ID code edit mode. Then set the desired digit using [CH Up]/[CH Down]/[TX Code CH Up]/[TX Code CH Down] or 10-keypad.\* (p. 14)

\*Depending on version

**TX CODE CHANNEL UP/DOWN KEYS**

Push to select a TX code channel directly.

**ID MEMORY READ KEY**

- Recalls detected ID codes.
  - Push this key, then push [CH Up]/[CH Down] for selection.
  - Up to 5 ID's are memorized.
- Push and hold to erase the selected memorized ID's.

**VOICE SCRAMBLER FUNCTION**

Push to toggle the voice scrambler function ON and OFF.

---

## 2 PANEL DESCRIPTION

### **COMPANDER KEY**

Push to toggle the compander function ON and OFF. The compander function reduces noise components from the transmitting audio to provide clear communication.

### **USER SET MODE KEY**

- ➔ Push and hold to enter user set mode.
  - During user set mode, push this key to select an item, and push [CH Up]/[CH Down] to change the value or condition.
- ➔ Push and hold this key again to exit user set mode.

### **OPT OUT KEYS**

Push to control the optional unit connector output signal level.

### **DIGITAL KEY** (BIIS operation only)

- ➔ Push to select the call ID list, transmit message and standby condition. Toggles between queue channel and received message record indication after queue channel is selected.
- ➔ Push and hold to select queue channel indication.

### **STATUS UP/DOWN KEYS** (BIIS operation only)

- ➔ While in the standby condition, push to display the transmit status indication and select a status number.
- ➔ When a received SDM is displayed, push to cancel the automatic scroll and scroll the message manually.
- ➔ When an SDM that contains more than 8 characters is displayed, push to scroll the message manually.

### ◇ **For SmarTrunk operation only**

#### **TRUNKING GROUP KEY**

Push to select the Trunking group.

#### **TURBO SPEEDIAL A/B/C/D KEYS**

Push to automatically dial a commonly used number with one push.

#### **CALL/CLEAR-DOWN KEYS**

Functions as [\*] and [#] keys on the 10-keypad.

- Push [\*] for call, push [#] for clear-down.

#### **TRUNKING CALLER ID KEY**

Push [Trunking Caller ID SW] to display the received ID record in sequence (while in SmarTrunk 3G™ operation).

## ■ Turning power ON

- ① Rotate [VOL] to turn the power ON.
- ② If the transceiver is programmed for a start up passcode, input the digit codes as directed by your dealer.
  - 10-keypad can be used for password input depending on version:
  - The keys in the table below can be used for password input:
  - The transceiver detects numbers in the same block as identical. Therefore “01234” and “56789” are the same.

KEY	P0	P1	P2	P3	DOWN
NUMBER	0	1	2	3	4
	5	6	7	8	9

- ③ When the “PASSWORD” indication does not clear after inputting 4 digits, the input code number may be incorrect. Turn the power off and start over in this case.

## ■ Channel selection

Several types of channel selections are available. Methods may differ according to your system set up.

### **NON-BANK TYPE:**

Push [UP] or [DOWN], or rotate [ROTARY SELECTOR]\* to select the desired operating channel, in sequence; or, push one of [MR-CH 1] to [MR-CH 4] keys to select a channel directly.

- Up to 16 pre-programmed channels can be selected via [ROTARY SELECTOR].\*

### **BANK TYPE:**

Push [BANK], then push [UP] or [DOWN] or rotate [ROTARY SELECTOR]\* to select the desired bank.

### **AUTOMATIC SCAN TYPE:**

Channel setting is not necessary for this type. When turning power ON, the transceiver automatically starts scanning. Scanning stops when receiving a call.

\*Depending on the pre-setting.

### 3 BASIC OPERATION

#### ■ Call procedure

When your system employs tone signaling (excluding CTCSS and DTCS), the call procedure may be necessary prior to voice transmission. The tone signalling employed may be a selective calling system which allows you to call specific station(s) only and prevent unwanted stations from contacting you.

- ① Select the desired TX code channel or 5-tone code according to your System Operator's instructions.
  - This may not be necessary depending on programming.
  - Refer to pgs. 13 or 14 for selection.
- ② Push the call key (assigned to one of the dealer programmable keys: [Up], [Down], [P0], [P1], [P2], [P3], [Red] and [Monitor]) or [PTT].
- ③ After transmitting a 5-tone code, the remainder of your communication can be carried out in the normal fashion.

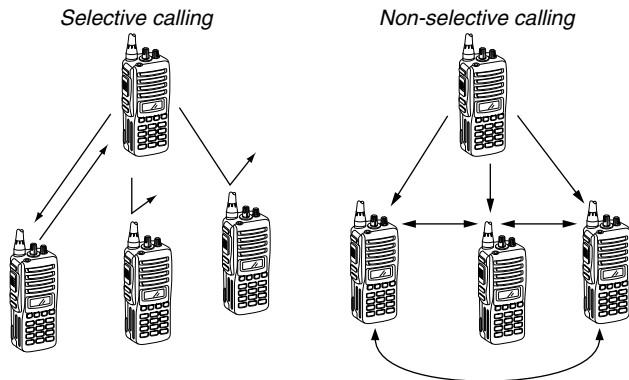

#### ■ Receiving and transmitting

▨ **NOTE:** Transmitting without an antenna may damage the transceiver. See p. 1 for antenna attachment.

##### **Receiving:**

- ① Rotate [VOL] to turn the power ON.
- ② Push [UP] or [DOWN], or rotate [ROTARY SELECTOR]\* to select a channel, in sequence.  
\*Depending on the pre-setting.
- ③ When receiving a call, adjust the audio output level to a comfortable listening level.

##### **Transmitting:**

Wait for the channel to become clear to avoid interference.

- ① While pushing and holding [PTT], speak into the microphone at a normal voice level.
- ② Release [PTT] to return to receive.

▨ **IMPORTANT:** To maximize the readability of your signal;

1. Pause briefly after pushing [PTT].
2. Hold the microphone 5 to 10 cm from your mouth, then speak into the microphone at a normal voice level.



### ◇ Transmitting notes

#### • Transmit inhibit function

The transceiver has several inhibit functions which restrict transmission under the following conditions:

- The channel is in mute condition ('Inaudible' condition; "M" does not appear.)
- The channel is busy.
- Un-matched (or matched) CTCSS is received. (Depending on the pre-setting.)
- The selected channel is a 'receive only' channel.

#### • Time-out timer

After continuous transmission for the pre-programmed time period, the time-out timer is activated, causing the transceiver to stop transmitting.

#### • Penalty timer

Once the time-out timer is activated, transmission is further inhibited for a period determined by the penalty timer.

### ◇ TX code channel selection

If the transceiver has [TX Code CH Select] assigned to it, indication can be toggled between the operating channel number (or name) and TX code channel number (or name). When the TX code channel number (or name) is displayed, [UP]/[DOWN] selects the TX code channel.

#### **TO SELECT A TX CHANNEL:**

- ① Push [TX Code CH Select]— a TX code channel appears.
- ② Push [UP] or [DOWN] to select the desired TX code channel.
- ③ Push [Call] (or [PTT] during MSK operation) to transmit the selected TX code.
- ④ Push [TX Code CH Select] again to return to the operating channel number indication.

#### **FOR TX CODE CHANNEL TYPE:**

If the transceiver has a [TX Code CH Up] or [TX Code CH Down] key assignment, the programmed TX code channel can be selected directly.

---

## 3 BASIC OPERATION

### ◇ TX code number edit

If the transceiver has [TX Code CH Select] or [TX Code Enter] assigned to it, TX code contents can be edited within the allowable digits.

#### **TO EDIT A TX CODE VIA [TX CODE CH SELECT] KEY:**

- ① Push [TX Code CH Select] to enter the TX code channel selection mode.
  - Select the desired channel using [UP] or [DOWN] if necessary.
- ② Push [TX Code CH Select] for 1 sec. to enter the TX code edit mode.
- ③ Push [TX Code CH Select] to select the desired digit to be edited.
- ④ Set the desired digit using [UP], [DOWN], [TX Code CH Up], [TX Code CH Down] or 10-keypad.\*
  - \*Depending on version.
- ⑤ Push [TX Code CH Select] to set the digit. The editable digit will move to the right automatically.
  - When the 10-keypad is used to set, the editable digit will move to the right automatically without pushing [TX Code CH Select].
- ⑥ Repeat ④ and ⑤ to input all allowable digits.
- ⑦ Push [Call] or [PTT] to transmit the edited TX code.

#### **TO EDIT A TX CODE VIA [TX CODE ENTER] KEY:**

- ① Select the desired TX code channel via [TX Code CH Up] or [TX Code CH Down].
- ② Push [TX Code Enter] to enter the TX code edit mode.
- ③ Push [TX Code Enter] to select the desired digit to be edited.
- ④ Set the desired digit using [UP], [DOWN], [TX Code CH Up] or [TX Code CH Down] or 10-keypad\*.
  - \*Depending on version.
- ⑤ Push [TX Code Enter] to set the digit. The editable digit will move to the right automatically.
  - When the 10-keypad is used to set, the editable digit will move to the right automatically without pushing [TX Code CH Select].
- ⑥ Repeat ④ and ⑤ to input all allowable digits.
- ⑦ Push [Call] or [PTT] to transmit the edited TX code.

### ◇ DTMF transmission

If the transceiver has [DTMF Autodial] assigned to it, the automatic DTMF transmission function is available. Up to 8 DTMF channels are available.

#### TO SELECT A TX CODE:

- ① Push [DTMF Autodial]— a DTMF channel appears.
- ② Push [UP] or [DOWN] to select the desired DTMF channel.
- ③ Push [DTMF Autodial] to transmit the DTMF code in the selected DTMF channel.

## ■ User set mode



User set mode is accessed with [User Set Mode] and allows you to set seldom-changed settings. In this case you can “customize” the transceiver operation to suit your preferences and operating style.

#### *Entering the user set mode:*

- ① Push and hold [User Set Mode] to enter user set mode. Push [User Set Mode] momentarily to select the item. Then push [UP] or [DOWN] to set the desired level/condition.
  - Available set mode functions are **Backlight**, **Beep**, **SQL Level**, **Mic Gain** and **Battery Voltage**.
- ② Push and hold [User Set Mode] to exit user set mode.

## ■ Scrambler function

The voice scrambler function provides private communication between stations. The frequency inversion type is equipped to all versions, moreover, the optional Rolling or Non-rolling type can be available.

- ① Push [Scrambler] to turn the scrambler function ON.
  - “” appears.
- ② Push [Scrambler] again to turn the scrambler function OFF.
  - “” disappears.

## ■ Default setting

The following functions are assigned to each programmable key as the default. However, the assigned function can be changed by your dealer. Ask your dealer for details.

/// **NOTE:** [TX Code Enter] must be assigned to any key.

- [P0]; Call : Push to transmit a 5-tone/BIIS call when the selected channel is a 5-tone or MSK channel, respectively.
- [P1]; Digital : Push to select the call list ID/transmit message, or to display the receive message record for selection.
- [P3]; TX Code Enter : Push to enter the direct ID code edit mode for both 5-tone and MSK.
- [UP]/[DOWN]; CH Up/Down : While in the standby condition, selects the operating channel. After pushing [Digital] or [TX Code CH Select], selects call list or TX code channel, respectively.
- [MONITOR]; Moni(Audi): Push this key after the communication to send a 'Clear down' signal during MSK channel operation.
- [P2]/[RED]; Null : No function is assigned.

## ■ Receiving a call

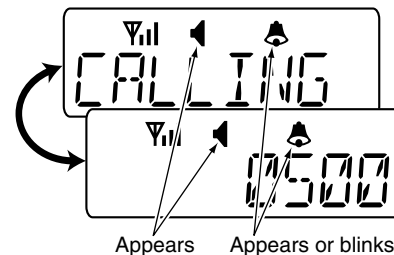

### ◆ Individual call

- When an individual call is received;
  - Beeps sound.
  - "📞" appears and the mute is released.
  - The programmed text message (e.g. "CALLING") and the calling station ID (or text) is displayed alternately, depending on the setting.
  - "📞" appears or blinks depending on the setting.





- Push and hold [PTT], then speak into the microphone at a normal voice level.
  - "🗣️" indicator appears.
- Release [PTT] to return to receive.
  - "📞" appears while receiving a signal.
- To finish the conversation, push [MONITOR] (Moni(Audi)) to send the 'Clear down' signal.
  - Either station can send a 'Clear down' signal.
  - "CLR DOWN" is displayed for 2 sec. (approx.).
  - "📞" disappears and the transceiver returns to the standby condition.

### ◆ Group call

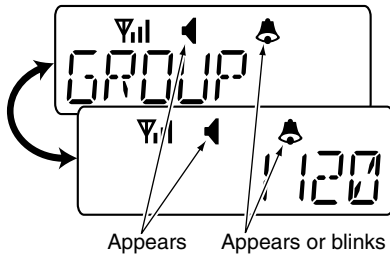
- ① When a group call is received;
  - Beeps sound.
  - “” appears and the mute is released.
  - The programmed text message (e.g. “GROUP”) and the calling station ID (or text) is displayed alternately, depending on the setting.
  - “” appears or blinks depending on the setting.



- ② Push and hold [PTT], then speak into the microphone at a normal voice level.
  - /// **NOTE:** Only one station is permitted to speak.
  - “” appears.
- ③ Release [PTT] to return to receive.
  - “” appears while receiving a signal.
- ④ To finish the conversation, push [MONITOR] (Moni(Audi)) to send the ‘Clear down’ signal.
  - Either station can send a ‘Clear down’ signal.
  - “CLR DOWN” is displayed for 2 sec. (approx.)
  - “” disappears and the transceiver returns to the standby condition.

### ◆ Displaying the received call record — Queue indication

The transceiver memorizes the calling station IDs for record. Up to 3 calls can be memorized, and the oldest call record is erased when a 4th call is received. However, once the transceiver is powered OFF, the all records are cleared.

- ① Push [P1] (Digital) for 1 sec.
  - Displays following indication.

*When a record is available*

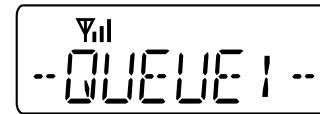

*When no record is available*



- ② Push [UP] or [DOWN] to select the desired call.
- ③ Push [P1] (Digital) for 1 sec. again to return to the standby condition.
  - When no operation is performed for 30 sec., the transceiver returns to the standby condition automatically.

## 4 BIIS OPERATION

### ■ Transmitting a call

Total of a 3 ways for code selection are available—selecting the call code from memory, entering the call code from the keypad and calling back from the queue channel record.

#### ◆ Using call memory

- ① While in the standby condition, push [P1] (Digital) to enter the call code memory channel selection mode.
  - “☎” appears.

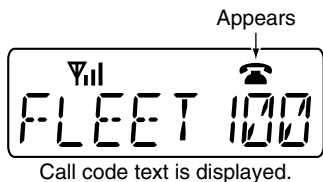

- ② Push [UP] or [DOWN] to select the desired call code.
- ③ Push [P0] (Call) or [PTT]\* to call.
  - \*PTT call can be made only when PTT call capability is permitted.
  - NOTE: When no answer back is received, the transmitter repeats the call 3 times (default) automatically, and “WAIT” is displayed during each call. However, an error beep sounds and “FAILED” is displayed when no answer back is received after the calls.
- ④ Push [PTT] to transmit; release to receive.
- ⑤ Push [MONITOR] (Moni(Audi)) to send the ‘Clear down’ signal.

#### ◆ Calling back from the queue channel

- ① While in the standby condition, push [P1] (Digital) for 1 sec. to enter the queue memory channel selection mode.
- ② Push [UP] or [DOWN] to select the desired record.

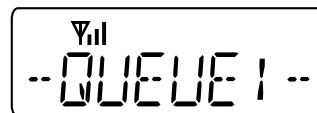

- ③ Push [P0] (Call) or [PTT]\* to call.
  - \*PTT call can be made only when PTT call capability is permitted.
  - NOTE: When no answer back is received, the transmitter repeats the call 3 times (default) automatically, and “WAIT” is displayed during each call. However, an error beep sounds and “FAILED” is displayed when no answer back is received after the calls.
- ④ Push [PTT] to transmit; release to receive.
- ⑤ Push [MONITOR] (Moni(Audi)) to send the ‘Clear down’ signal.

### ◆ Direct code entry

- ① While in the standby condition, push [P3] (TX Code Enter) to enter the TX code edit mode.
  - Editable code digit blinks.

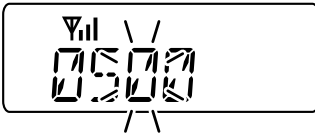

- ② Push [P3] (TX Code Enter) to select the desired digit to be edited.
  - Editable digit differs according to the setting.
- ③ Set the desired digit using [CH Up]/[CH Down]/[TX Code CH Up]/[TX Code CH Down] or 10-keypad.\*
  - \*Depending on version
- ④ Push [P3] (TX Code Enter) to set the digit, then the editable digit will move to the right automatically.
  - When the 10-keypad is used to set, the editable digit will move to the right automatically without pushing [P3] (TX Code Enter).
- ⑤ Repeat ③ and ④ to input all allowable digits.
- ⑥ Push [P0] (Call) or [PTT]\* to call.
  - \*PTT call can be made only when PTT call capability is permitted.

 **NOTE:** When no answer back is received, the transceiver repeats the call 3 times (default) automatically, and “WAIT” is displayed during each call. However, an error beep sounds and “FRILE” is displayed when no answer back is received after the calls.

- ⑦ Push [PTT] to transmit; release to receive.
- ⑧ Push [MONITOR] (Moni(Audi)) to send the ‘Clear down’ signal.

---

#### ***For your information***

When the “UpDate” setting for the call code is enabled, the set code is overwritten into the call code memory.

---

## 4 BIIS OPERATION

### ■ Receiving a message

#### ◆ Receiving a status message

- ① When a status message is received;
  - Beeps sound.
  - The calling station ID (or text) and the status message is displayed alternately, depending on the setting.

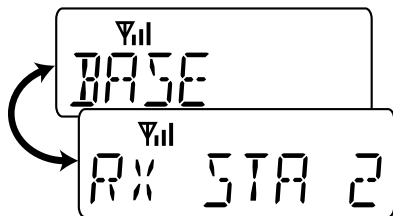

- ② Push [MONITOR] (Moni(Audi)) to return to the standby condition.

**NOTE:** Only the calling station ID (or text) is displayed (no message is displayed alternately) when the scroll timer is set to 'OFF.' In this case, push [Status Up]/[Status Down] to display the status message manually.

#### ◆ Receiving an SDM

- ① When an SDM is received;
  - Beeps sound.
  - The calling station ID (or text) and the SDM is displayed alternately, depending on the setting.

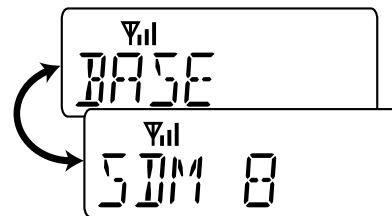

- ② When the received SDM includes more than 8 characters, "►" appears and the message scrolls automatically, when the automatic scroll function is activated.
  - Push [Status Up]/[Status Down] to scroll the message manually.
- ③ Push [MONITOR] (Moni(Audi)) to return to the standby condition.



### ◆ Received message selection

The transceiver memorizes the received messages for record. Up to 6 messages for status and SDM, or 95 character SDM's can be memorized. The oldest message is erased when the 7th message is received. However, once the transceiver is powered OFF, all messages are cleared.

- ① Push [P1] (Digital) for 1 sec.
  - Displays queue memory.
- ② Push [P1] (Digital) momentarily.
  - Displays message memory.

#### *When a message is available*

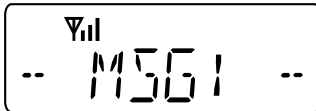

#### *When no message is available*

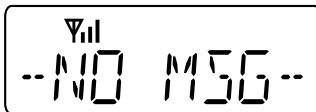

- ③ Push [UP] or [DOWN] to select the desired message.
  - When selecting the SDM that includes more than 8 characters, "►" appears and the message scrolls automatically, when the automatic scroll function is activated.
  - Push [Status Up]/[Status Down] to scroll the message manually.
- ④ Push [P1] (Digital) for 1 sec. again to return to the standby condition.
  - When no operation is performed for 30 sec., the transceiver returns to the standby condition automatically.

## 4 BIIS OPERATION

### ■ Transmitting a status

#### ◇ General

The status message can be selected with the programmed text, and the message text is also displayed on the function display of the called station.

Up to 24 status types (1 to 24) are available, and the status messages 22 and 24 have designated meanings.

Status 22: Emergency\*

Status 24: GPS request

\*The status 22 can also be used as a normal status message by disabling the designated meaning. However, the status 24 is fixed.

The status call can be sent with both individual and group calls.

#### ◇ Transmitting a status

- ① While in the standby condition, push [P1] (Digital), then push [UP] or [DOWN] to select the desired station/group code.
- ② Push [P1] (Digital) again, then push [UP] or [DOWN] to select the desired status message.

Or, you can select the desired status message using [Status Up]/[Status Down] key directly.

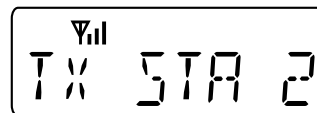

Status message is displayed.

- ③ Push [P0] (Call) or [PTT]\* to transmit the status message to the selected station/group.  
\*PTT call can be made only when PTT call capability is permitted.  
•2 beeps will sound and the transceiver returns to the standby condition automatically when the transmission is successful.

## ■ Transmitting an SDM

### ◇ General

The short data message, SDM, can be sent to an individual station or group stations. Also, 8 SDM memory channels are available and the messages can be edited via PC programming.

### ◇ Transmitting an SDM

- ① While in the standby condition, push [P1] (Digital), then push [UP] or [DOWN] to select the desired station/group code.
- ② Push [P1] (Digital) again, then push [UP] or [DOWN] to select the desired SDM.

Or, you can select the desired SDM using [Status Up]/[Status Down] key directly.

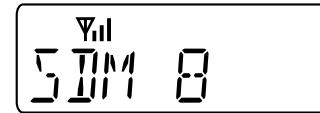

SDM is displayed.

- ③ Push [P0] (Call) or [PTT]\* to transmit the SDM to the selected station/group.

\*PTT call can be made only when PTT call capability is permitted.

•2 beeps will sound and the transceiver returns to the standby condition automatically when the transmission is successful.

## 4 BIIS OPERATION

### ◆ Programming an SDM memory

(10-keypad version is required)

- ① During standby condition, push [P1] (Digital) twice, then push [UP] or [DOWN] to select the desired SDM to be edited.
- ② Push [\*] or [#] to enter the message editing condition.
  - The first character blinks when [#] is pushed, the last character blinks when [\*] is pushed as below.

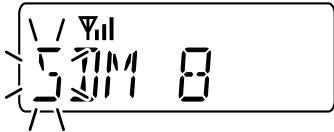

- ③ Push the appropriate digit key, [0] to [9], to enter the desired character.
  - See the table at right for the available characters.
  - Pushing [UP] also enters space, pushing [DOWN] deletes the selected character.
- ④ Push [#] to move the cursor to the right, push [\*] to move the cursor to the left.
- ⑤ Repeat steps ③ and ④ to set the desired text message.
- ⑥ Push [P1] (Digital) for 1 sec. to overwrite the set content into the memory.
  - Push [P1] (Digital) momentarily to cancel the editing and return to the original message indication.

### • Available characters

Key	Characters
[0]	0 (0) . (.) ! (!) ? (?) ' (') " (") , (,) ; (;) : (:) ; (;) : (:)
[1]	_ ( _ ) ' ( ' ) > ( > ) < ( < ) > ( > ) [ ( [ ) ] ( ] )
[2]	! (1) (Space) # (#) * (*) / (/) + (+) - (-) = (=) \ ( \ )
[3]	& (&) % (%) \$ (\$) @ (@) ^ (^)
[4]	2 (2) A (A) B (B) C (C) a (a) b (b) c (c)
[5]	3 (3) D (D) E (E) F (F) d (d) e (e) f (f)
[6]	4 (4) G (G) H (H) I (I) g (g) h (h) i (i)
[7]	5 (5) J (J) K (K) L (L) j (j) k (k) l (l)
[8]	6 (6) M (M) N (N) O (O) m (m) n (n) o (o)
[9]	7 (7) P (P) Q (Q) R (R) S (S) p (p) q (q) r (r) s (s)
[0]	8 (8) T (T) U (U) V (V) t (t) u (u) v (v)
[1]	9 (9) W (W) X (X) Y (Y) Z (Z) w (w) x (x) y (y) z (z)

**NOTE:** Once the pre-programmed character including a decimal point is rewritten with the 10-keypad, the decimal point cannot be displayed again.

## ■ Position data transmission

When the optional cable and a GPS receiver is connected to the transceiver, the position (longitude and latitude) data can be transmitted automatically.

Ask your dealer or system operator for connection details.

The position data is transmitted when;

- Status 24 message is received
  - \*When the status 24 message, GPS request, is received.
- Fully automatic
  - When automatic position transmission is enabled, send the position data according to 'Time Marker' and 'Interval Timer' settings.
- PTT is released
  - When 'Send with Logoff' is enabled.
  - Set the 'Log-In/Off' item as 'L-OFF.'
- After sending a status message
  - When 'Send with Status' is enabled.
- After sending an SDM
  - When 'Send with SDM' is enabled.
- After sending status 22 (Emergency)
  - When 'Send with Emergency' is enabled.

## ■ Printer connection

When the optional cable is connected to the transceiver, a printer can be connected to print out the received SDM content and the ID of the station who sent the message.

Ask your dealer or system operator for connection details.

## ■ Digital ANI

The own ID can be transmitted each time the PTT is pushed (log-in) or released (log-off) during individual or group call communications.

By receiving the ANI, the communication log can be recorded when using a PC dispatch application.

In addition, when using the ANI with log-in, the PTT side tone function can be used to inform you that the ID is sent and voice communication can be performed.

---

## 4 BIIS OPERATION

### ■ Auto emergency transmission

When [Emergency Single (Silent)] or [Emergency Repeat (Silent)] is pushed, an emergency signal is automatically transmitted for the specified time period.

The status 22 (Emergency) is sent to the selected ID station, and the position data is transmitted after the emergency signal when a GPS receiver is connected to the transceiver.

The emergency transmission is performed on the emergency channel, however, when no emergency channel is specified, the signal is transmitted on the previously selected channel.

There is no change in the function display or beep emission during automatic emergency transmission.

### ■ Stun function

When the specified ID, set as a killer ID, is received, the stun function is activated.

When the killer ID is received, the transceiver switches to the passcode required condition. Entering of the passcode via the keypad is necessary to operate the transceiver again in this case.

### ■ BIIS indication

The following indications are available for the BIIS operation on an MSK channel.

*CONNECT* : Individual/group call is successful.

*OK* : Message (status or SDM) transmission is successful.

*FAILED* : No answer back is received.

*WAIT* : Appears during retry of the call (2nd call).

*CLR DOWN* : End the communication.

*BUSY* : Operating channel is in the busy condition.

### ■ Priority A channel selection

When one of the following operations is performed, the transceiver selects the Priority A channel automatically.

Priority A is selected when;

- Clear down signal is received/transmitted
  - Set the 'Move to PrioA CH' item as 'Clear down.'
- Turning the power ON
  - The Priority A channel is selected each time the transceiver power is turned ON.
- Status call
  - The Priority A channel is selected when transmitting a status call.
  - Enable the 'Send Status on PrioA CH' item in the MSK configuration.

## ■ Man Down Emergency Call

The optional UT-113 MAN DOWN UNIT is required for this function.

The man down emergency call function transmits an emergency call automatically, when the transceiver has been left in a horizontal position.

This function can be performed for both 5-tone and MSK channels.

After the emergency call, the transceiver performs transmission and reception alternately with the following conditions:

- Transmits the microphone signals.
- Receives the signal and emits audio.

When the emergency reset signal is received, the function is cancelled.

**/// IMPORTANT:** Set an emergency channel individually, to provide certain emergency call operation is recommended.

## ■ SmarTrunk II™, SmarTrunk 3G™ and conventional modes

This transceiver is capable of SmarTrunk II™/SmarTrunk 3G™ functions.

The optional UT-105/UT-117 allow communications in conventional channels, SmarTrunk II™/SmarTrunk 3G™ channels. Select a channel bank for SmarTrunk II™/SmarTrunk 3G™ before trunking operation.

- Push [BANK] several times to select a channel bank for conventional channels or SmarTrunk II™/SmarTrunk 3G™ channels.
  - Scanning starts when a channel bank for SmarTrunk II™/SmarTrunk 3G™ operation is selected.
  - Contact your Dealer for channel bank details.

## ■ SmarTrunk II™ and SmarTrunk 3G™ operation

These features are enabled by a Dealer and may not be available in your system. Contact your Dealer for details.

### ◇ Receiving a call\*<sup>1</sup>

When you hear ringing, push [\*] to answer.

- For a group call, you hear a short ring followed by two short beeps. You do not have to answer a group call to hear it over the air.

### ◇ Terminating a call\*<sup>1</sup>

After completing a call, push [#] to disconnect (hang up).

**/// IMPORTANT:** If one person in the conversation terminates a call, all participants will be cut off.

### ◇ Last number re-dial\*<sup>1</sup>

Push [\*] 2times to automatically re-dial the last called number.

- A high-pitched beep indicates that the number is accepted.

### ◇ Clear channel alerting\*<sup>1</sup>

If all channels are busy, the transceiver automatically begins searching for an open channel and beeps every ten seconds. When two short beeps (low-pitched, then high-pitched) are heard, a channel is available. Push [\*], [\*] immediately to re-dial the last number.



### ◇ PTT dispatch operation\*<sup>1</sup>

- ① Push [PTT] once (without dialling) to initiate a dispatch call.
- ② Begin talking after you hear three beeps (one short, high-pitched, two very-short, low-pitched).
- ③ Receiving a dispatch call is indicated by the same three-beep sequence.
  - It is not necessary to push [\*] to answer a dispatch call.

### ◇ Placing a telephone call\*<sup>2</sup>

Enter the phone number followed by [1], [\*].

- A high-pitched beep indicates that the number is accepted.
- When the called party answers, push the [PTT] switch to talk, and release it to listen.

### ◇ Calling another local system subscriber\*<sup>2</sup>

Enter the subscriber number followed by [3], [\*].

- A high-pitched beep indicates that the number is accepted.
- You hear ringing, then two short beeps when the subscriber answers.
- If the other subscriber is on another call or out of range, you hear a fast busy signal and the call terminates automatically.

### ◇ Memory speed-dialling\*<sup>2</sup>

To automatically dial a commonly used number from memory:

- Push [\*] followed by the memory location (0–9).

### ◇ Emergency call\*<sup>2</sup>

Push [0], [\*] to initiate an emergency call.

- Contact your dealer for details.

### ◇ Turbo Speedial

To automatically dial a commonly used number with one push:

- Push one of the turbo Speedials ([A], [B], [C] or [D]).

### ◇ Programming memory speed dial

- ① Push and hold [\*] until you hear a high-pitched beep.
- ② Enter the memory location (0–9, A, B, C, D), the telephone or subscriber number, then [1], [\*] (or [3], [\*] if for another system subscriber).
  - A high-pitched beep indicates successful programming.
  - Memories [A]–[D] are used for the Turbo Speedial.

### ◇ System busy indication

If all channels are busy, three low beeps sound after you initiate a call. Try the call again later.

### ◇ Displaying the received ID record

(Available for SmarTrunk 3G™ only)

Push [Trunking Caller ID SW] to display the received ID record in sequence.

- The latest received ID is displayed at first.
- The record is cleared when the transceiver is turned OFF.

\*<sup>1</sup> Available for 4-key version when the [\*] or [#] key function is assigned to any programmable key.

\*<sup>2</sup> Available for 10-keypad version only. Use the Turbo Speedial function instead.

**NOTE:** For additional operating instructions, contact your Dealer.

## ■ Optional unit installation

Install the optional unit as follows:

- ① Rotate [VOL] to turn the power OFF, and remove the battery pack. (p. 2)
- ② Remove the unit cover.

**NOTE:** Use a flat head screw driver or a similar flat instrument, and insert into the hollow of the chassis, then lift and take away the unit cover. (The removed cover cannot be used again.)

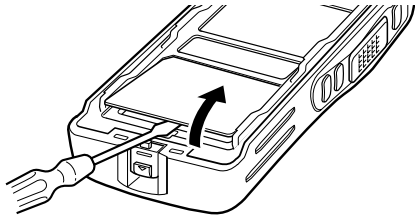

- ③ Install the unit as shown below.

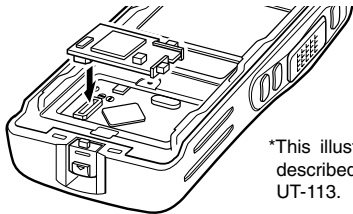

\*This illustration is described with the UT-113.

- ④ Replace the unit cover and the battery pack, then rotate [VOL] to turn the power ON.

**NOTE:** The optional UT-109/UT-110 SCRAMBLER UNITS or UT-117 (scrambler version) requires some PC board modifications. Please refer to the additional installation as at right.

## ■ Scrambler unit installation

The following PC board modification is required when installing the optional UT-109, UT-110 or UT-117 (scrambler version):

- ① Rotate [VOL] to turn the power OFF, and remove the battery pack. (p. 2)
- ② Remove the unit cover as shown on p. 30 (Optional unit installation).
- ③ Cut the pattern on the PCB at the TX mic circuit (MIC) and RX AF circuit (DISC) as shown below.
- ④ Install the scrambler unit as described in the Optional unit installation (p. 30).
- ⑤ Replace the unit cover and the battery pack, then rotate [VOL] to turn the power ON.

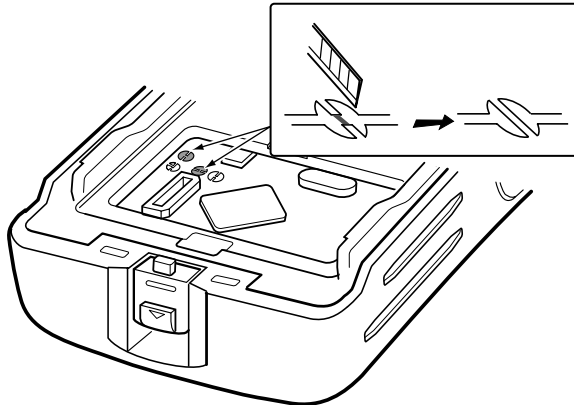

**NOTE: When uninstalling the scrambler unit**  
 Be sure to re-solder the disconnected points at left, otherwise no TX modulation or AF output is available.

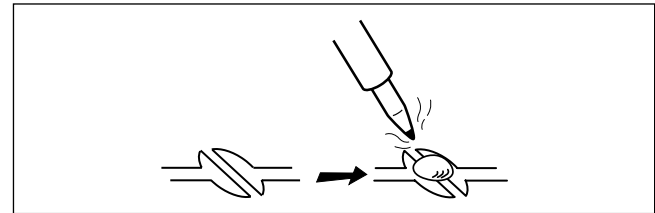

## ■ Battery charging

Prior to using the transceiver for the first time, the battery pack must be fully charged for optimum life and operation.

**CAUTION:** To avoid damage to the transceiver, turn the power OFF while charging.

- Recommended temperature range for charging: +10°C to +40°C
- Use the specified chargers (BC-119N, BC-121N and BC-160). **NEVER** use another manufacture's charger.
- Use the specified AC adapter. **NEVER** use another manufacture's adapter.

### ***Recommendation:***

Charge the supplied battery pack for a maximum of up to 10 hours. Li-Ion batteries are different from Ni-Cd batteries in that it is not necessary to completely charge and discharge them to prolong the battery life. Therefore, charging the battery in intervals, and not for extended periods is recommended.

## ■ Battery caution

**CAUTION! NEVER** insert battery pack/transceiver (with the battery pack attached) in a wet or soiled condition into the charger. This may result in corrosion of the charger terminals or damage to the charger. The charger is not waterproof and water can easily get into it.

**NEVER** incinerate used battery packs. Internal battery gas may cause an explosion.

**NEVER** immerse the battery pack in water. If the battery pack becomes wet, be sure to wipe it dry **BEFORE** attaching it to the transceiver.

**NEVER** short the terminals of the battery pack. Also, current may flow into nearby metal objects, such as a necklace, etc. Therefore, be careful when carrying with, or placing near metal objects, carrying in handbags, etc.

**AVOID** leaving the battery pack in a fully charged, or completely discharged condition for long time. It causes shorter battery life. In case of leaving the battery pack unused for a long time, it must be kept safely after discharge, or use the battery until the battery indicator appears, then remove it from the transceiver.

If your battery pack seems to have no capacity even after being charged, fully charge the battery pack again. If the batteries still do not retain a charge (or very little), new battery pack must be purchased.

## ■ Optional battery chargers

### ◇ AD-106 installation

- ① Install the AD-106 desktop charger adapter into the holder space of the BC-119N/BC-121N.
- ② Connect the plugs of the BC-119N/BC-121N to the AD-106 desktop charger adapter with the connector, then install the adapter into the charger with the supplied screws.

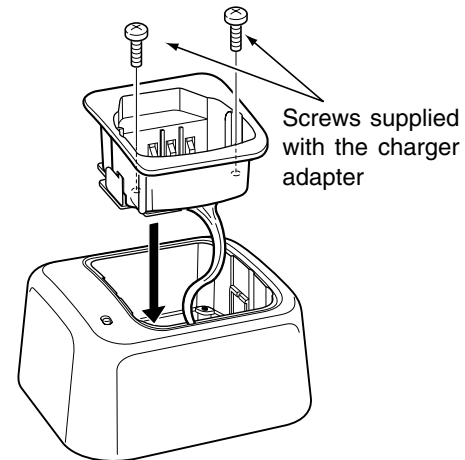
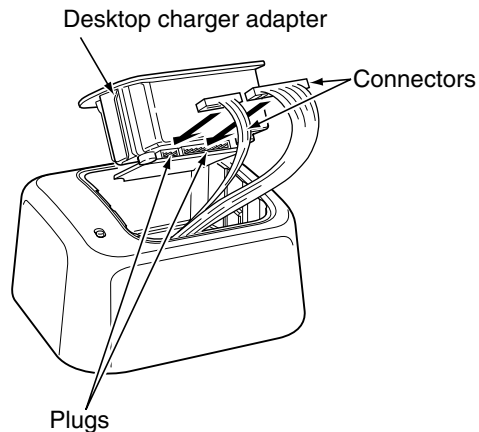

## 7 BATTERY CHARGING

### ◇ Rapid charging with the BC-119N+AD-106

The optional BC-119N provides rapid charging of battery packs. The following are additionally required.

- AD-106 charger adapter
- An AC adapter (may be supplied with BC-119N depending on version) or the DC power cable (OPC-515L/CP-17L).

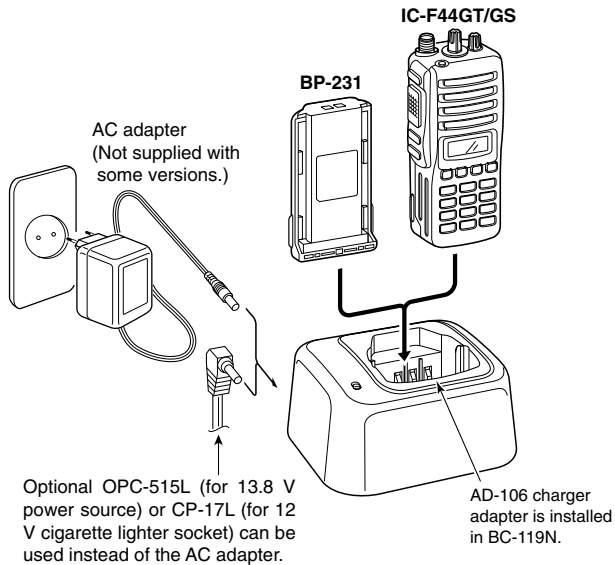

### ◇ Rapid charging with the BC-121N+AD-106

The optional BC-121N allows up to 6 battery packs to be charged simultaneously. The following are additionally required.

- Six AD-106 charger adapters
- An AC adapter (BC-124)

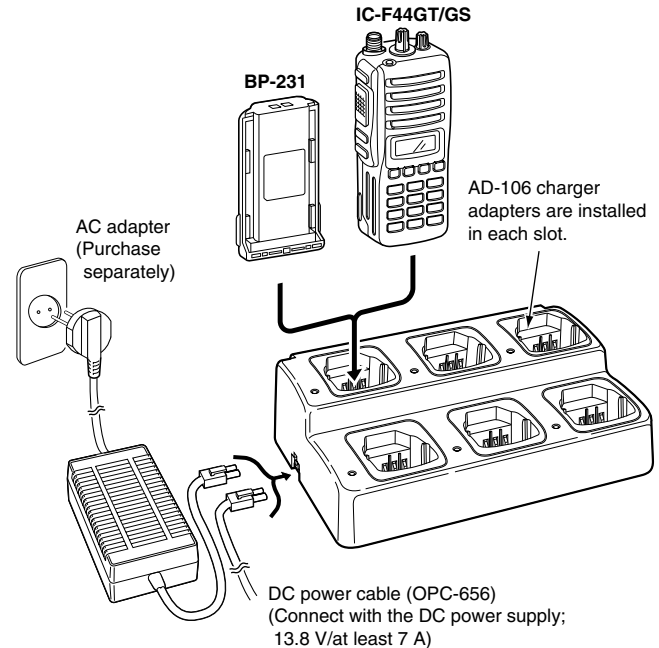

**IMPORTANT!: Battery charging**

Ensure the sides of the battery pack are correctly aligned with the charger groves. (This illustration is described with the BC-119N.)

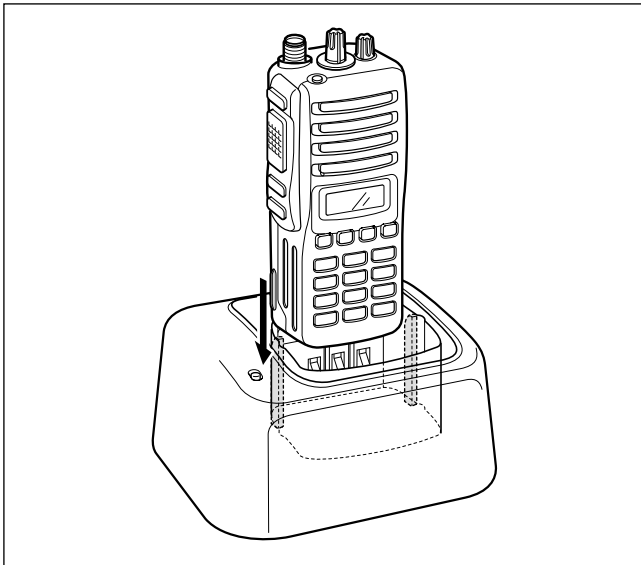

# 8

## SWIVEL BELT CLIP

### ■ MB-93 contents

	Qty.
① Belt clip .....	1
② Base clip .....	1

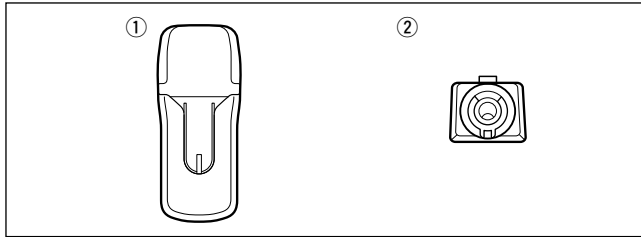

### ■ To attach

- ① Release the battery pack if it is attached. (p. 2)
- ② Slide the base clip in the direction of the arrow until the base clip is locked and makes a 'click' sound.

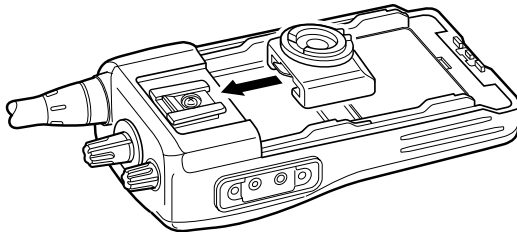

- ③ Clip the belt clip to a part of your belt. And insert the transceiver into the belt clip until the base clip inserted fully into the groove.

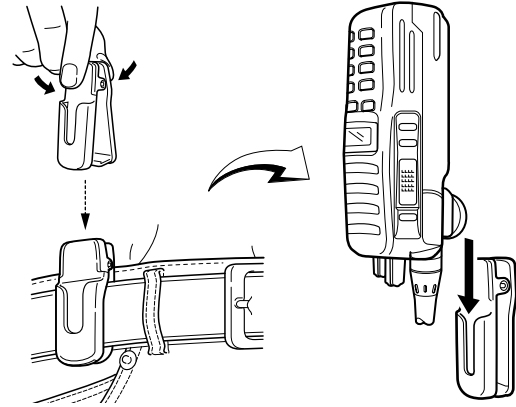

- ④ Once the transceiver is locked in place, it swivels as illustrated below.

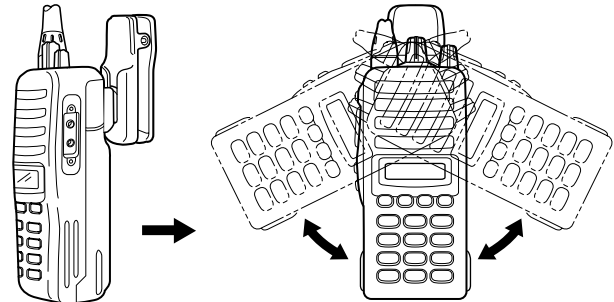



## ■ To detach

- ① Turn the transceiver upside down in the direction of the arrow and pull out from the belt clip.

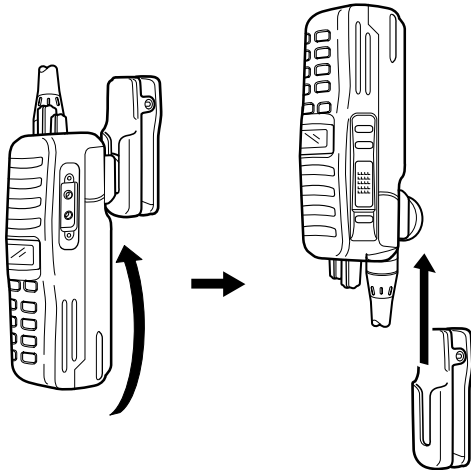

- ② Release the battery pack if it is attached. (p. 2)
- ③ Pinch the clip (①), and slide the base clip in the direction of the arrow (②).

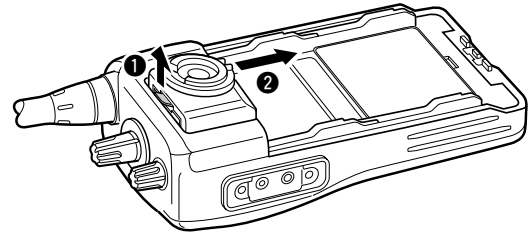

**CAUTION!**  
**HOLD THE TRANSCEIVER TIGHTLY, WHEN HANGING OR DETACHING THE TRANSCEIVER FROM THE BELT CLIP.**  
Otherwise the transceiver may not be attached to the holder or swivel properly if the transceiver is accidentally dropped and the base clip is scratched or damaged.

### ◇ BATTERY PACK

- **BP-230** Li-Ion BATTERY PACK  
7.4 V/800 mAh Li-Ion battery pack, allows more than 6 hours operation.
- **BP-231** Li-Ion BATTERY PACK  
7.4 V/1150 mAh Li-Ion battery pack, allows more than 8 hours operation. The same as supplied with the transceiver.
- **BP-232** Li-Ion BATTERY PACK  
7.4 V/2000 mAh Li-Ion battery pack, allows more than 16 hours operation.

### ◇ CHARGERS

- **BC-119N** DESKTOP CHARGER + **AD-106** CHARGER ADAPTER + **BC-145** AC ADAPTER  
For rapid charging of battery packs. An AC adapter is supplied with the charger depending on versions. Charging time: approx. 2 hours when BP-231 is attached.
- **BC-121N** MULTI-CHARGER + **AD-106** CHARGER ADAPTER (6 pcs.) + **BC-124** AC ADAPTER  
For rapid charging of up to 6 battery packs (six AD-106's are required) simultaneously. An AC adapter should be purchased separately. Charging time: approx. 2 hours when BP-231 is attached.
- **BC-160** DESKTOP CHARGER + **BC-145** AC ADAPTER  
For rapid charging of battery packs. An AC adapter is supplied with the charger depending on versions. Charging time: approx. 2 hours when BP-231 is attached.  
(Available in the near future)

### ◇ BELT CLIPS

- **MB-93** SWIVEL BELT CLIP
- **MB-94** BELT CLIP  
Exclusive alligator-type belt clip. The same as supplied with the transceiver.
- **MB-96\*/96F** LEATHER BELT HANGER  
\*MB-93's base clip is required.

### ◇ OPTIONAL UNITS

- **UT-108** DTMF DECODER UNIT  
Provides pager and code squelch capabilities.
- **UT-109 (#02)/UT-110 (#02)** SCRAMBLER UNITS  
Non-rolling type (UT-109)/Rolling type (UT-110) voice scrambler unit provides higher communication security.
- **UT-113** MAN DOWN UNIT  
Provides a measure of safety when working in a hazardous environment, etc.
- **UT-105** SmarTrunk II™ LOGIC BOARD  
Provides SmarTrunk II™ capabilities.
- **UT-117** SmarTrunk 3G™ LOGIC BOARD  
Provides SmarTrunk 3G™ capabilities.  
In addition to SmarTrunk 3G™ capabilities, scrambler support version is available.  
(Available in the near future)

## ◇ DC CABLES

- **CP-17L** CIGARETTE LIGHTER CABLE  
Allows charging of the battery pack through a 12 V cigarette lighter socket. (For BC-119N)
- **OPC-515L/OPC-656** DC POWER CABLES  
Allows charging of the battery pack using a 13.8 V power source instead of the AC adapter.  
OPC-515L: For BC-119N  
OPC-656 : For BC-121N

## ◇ OTHER OPTIONS

- **SP-13** EARPHONE  
Provides clear receive audio in noisy environment.
- **HM-131L** SPEAKER-MICROPHONE  
Combination speaker-microphone that provides convenient operation while hanging the transceiver from your belt.
- **HS-94/HS-95/HS-97** HEADSET + **VS-1L** VOX/PTT CASE  
HS-94: Ear-piece type  
HS-95: Neck-arm type  
HS-97: Throat microphone  
VS-1L: VOX/PTT switch box for hands-free operation, etc.
- **FA-SC73US** STUBBY ANTENNA  
Shorter UHF antenna. Frequency range: 450–490 MHz



CE versions of the IC-F44GT/GS which display the “CE” symbol on the serial number seal, comply with the essential requirements of the European Radio and Telecommunication Terminal Directive 1999/5/EC.



This warning symbol indicates that this equipment operates in non-harmonised frequency bands and/or may be subject to licensing conditions in the country of use. Be sure to check that you have the correct version of this radio or the correct programming of this radio, to comply with national licensing requirement.



We Icom Inc. Japan  
1-1-32, Kamiminami, Hirano-ku  
Osaka 547-0003, Japan

Declare on our sole responsibility that this equipment complies with the essential requirements of the Radio and Telecommunications Terminal Equipment Directive, 1999/5/EC, and that any applicable Essential Test Suite measurements have been performed.

**Kind of equipment:** UHF TRANSCEIVER

**Type-designation:** IC-F44GT/GS

400–470 MHz 12.5 kHz/20 kHz/25 kHz

**Version (where applicable):**

This compliance is based on conformity with the following harmonised standards, specifications or documents:

- i) EN 301 489-1 v1.3.1 (Sept 2001)
- ii) EN 301 489-5 (August 2000)
- iii) EN 60950 (August 1992+A11)
- iv) EN 300 086-2 (March 2001)
- v) EN 300 219-2 (March 2001)
- vi) EN 300 113-2 (March 2001)

## DECLARATION OF CONFORMITY

CE0168!

Düsseldorf 30th Apr. 2004  
Place and date of issue

Icom (Europe) GmbH  
Himmelgeisterstraße 100  
D-40225 Düsseldorf

Authorized representative name

H. Ikegami  
General Manager

Signature

Icom Inc.







**Count on us!**

**< Intended Country of Use >**

- GER  FRA  ESP  SWE  
 AUT  NED  POR  DEN  
 GBR  BEL  ITA  FIN  
 IRL  LUX  GRE  SUI  
 NOR